

# ENERGY EDUCATION

Mauri mahi, mauri ora

ENERGY NEWS FROM THE REGION, COUNTRY AND WORLD | SEPTEMBER 2021



## WITT NEWS

### New Energy courses under development at WITT

**Taranaki is experiencing the development of alternative energy industries and usages that have the potential to create a range of new career pathways that WITT is preparing to support.**

WITT is positively connected to many industries which will lead the transition, enabling their curriculum to maintain a level of relevance and responsiveness to those industry needs, which many other academic and vocational institutions struggle to have.

Some of the areas that are anticipated to emerge include electric vehicles; hydrogen fuel technology; renewable generation technologies, particularly wind, solar, geothermal, wave and tidal.

WITT will support the energy industry by training work-ready graduates who are skilled in the

latest technologies.

WITT is building relationships beyond the region to support quality workforce education with a focus on teaching, learning and research. Some of those relationships include Victoria University and the University of Canterbury, both who have world-class engineering, energy and research capability. Supporting Taranaki's existing and future energy workforce will rely on the development of a high-quality curriculum design.

Forming a consortium with expert representation from the energy sector, other tertiary colleges, Taranaki's District and Regional councils will help lay the foundation to support Taranaki's future economic prosperity.

In 2018, MBIE estimated that the ban on oil and gas exploration permits would remove over 3,000 jobs. That will likely happen if we do nothing. But in doing

something today we can change our future positively.

WITT's determination to assist workforce transition is very much part of Taranaki's economic plan for the future.



Kyle Hall, Director NZIHT - NZ School of Engineering, Energy & Infrastructure  
[K.Hall@witt.ac.nz](mailto:K.Hall@witt.ac.nz)

20 Bell Street  
New Plymouth 4310

**witt.ac.nz**  
0800 948 869



**ENERGY EDUCATION**  
Mauri mahi , mauri ora  
[energy@witt.ac.nz](mailto:energy@witt.ac.nz)  
Ph. 027 201 3004

**Bachelor of Engineering Technology Civil/Mechanical (Level 7)**

**Enrol Now for March 2022**

WITT's three-year engineering degree, offers a pathway into engineering, construction and related industries, including EV (electric vehicle) maintenance. Energy courses are currently being developed.

<https://get.nzih.co.nz/academic-programmes/>

WESTERN INSTITUTE OF TECHNOLOGY AT TARANAKI  
**LOW EMISSIONS ENERGY WORKSHOP**  
Bringing together the energy sector for vocational education excellence and industry success.  
Enquiries to [energy@witt.ac.nz](mailto:energy@witt.ac.nz)

WESTERN INSTITUTE OF TECHNOLOGY AT TARANAKI  
TE KURA MATATINI O TARANAKI

**BUILDING TOMORROW'S WORKFORCE TODAY**



## TECHNOLOGY

**Energy is fundamental to the economy and survival in today's world. Deployments of new technologies and the search for alternative energy sources have high priority.**

Leveraging existing resources, new products, and strategies that extend value for existing projects can attract capital.

It is in everyone's interest to reduce waste plastic, reuse goods containing high calorific values as high as crude oil's calorific value, and recycle materials as landfills are no longer an appropriate way to dispose of the wastes.

Pyrolysis of plastic wastes is a well-known method to minimise the environmental effect. Pyrolysis is an endothermic chemical process that decomposes organic components in an oxygen-free atmosphere. It converts plastic waste into energy in the form of solid, liquid, and gaseous

fuels. Conventional heat sources are well established on an industrial scale around the world. Using microwaves as a heat source would open a new horizon in electrification and high-temperature process heat.

Microwave energy can be delivered directly to the reacting or processing species by using their dielectric properties or adding absorbers to materials that allow more volumetric heating of materials. The high heating rate can be several orders of magnitude greater than with conventional heating. Microwave generators can respond quickly to changes in process parameters with a feedback loop of an automated process. Microwave heating results from induced currents, so the heating tends to be volumetric; however, the material's properties influence the penetration of microwaves. The field penetrates the materials, loses power, and therefore the field intensity decreases, suggesting that heating may not be uniform.

Microwaves interact in three ways



**Dr. Ellie Khaghani**

Ellie joined the Western Institute of Technology at Taranaki (WITT) in 2019. She holds a PhD degree in Chemical and Process Engineering with a research interest in waste to energy. She also holds a Masters degree in Petroleum Engineering and previously worked as a reservoir and process engineer in the oil and gas industry. She currently teaches engineering courses at WITT and acts as energy lead.

with different materials. It is reflected by conductors, transmitted by perfect insulators, or absorbed and decayed on the way inside

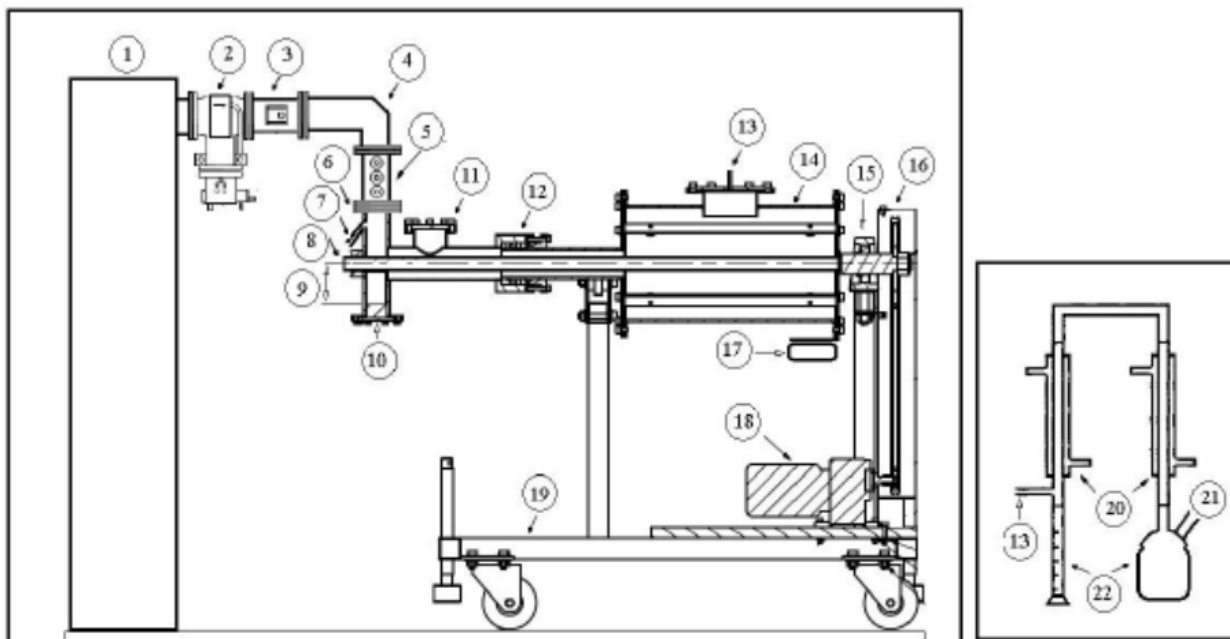

## Schematic of the microwave pyrolysis of plastic unit to produce fuel & useful chemicals

1) Generator (6kW), 2) Isolator (Circulator + Dummy load), 3) Directional coupler, 4) Bend, 5)3-stub tuner, 6) Quartz window, 7) Nitrogen inlet, 8) Central conductor, 9) Step height, 10) Step, 11) Rupture disk, 12) Gland, 13) Product outlet in microwave unit and product inlet in condensation system, 14) Reactor (Applicator), 15) Bearing, 16) Gear transition, 17) Wireless temperature data logger, 18) Adjustable speed electrical machinery, 19) Stand, 20) Condensers, 21) Outlet of non-condensable gases, 22) Collection flasks.

materials depending on their dielectric properties. The heat is generated in dielectric materials due to the agitation of molecules by the alternating electromagnetic field.

The advantages of microwave technology may facilitate moving forward to produce a clean, fast, and high-quality product. Further study should help to understand a clear picture of microwave pyrolysis of plastic process at high temperature. Challenges such as controlling electromagnetic field and uniformity, temperature measurements may require more sophisticated approaches to be tackled. Albeit in the light of the present technique and instrument of temperature measurement, it is not easy to acquire a precise result of the temperature distribution from the interior of the medium at high frequency and high temperature. The only question that remains to be answered is whether it is possible to achieve microwave pyrolysis of plastic with uniform heating in much less time than conventional heating on a reasonable scale and economical.

Microwave technology can benefit chemical processing because products

can be heated volumetrically instead of surface heating via convection and conduction. It has a unique selective heating feature that conventional methods cannot provide.

Microwave technology has been established in different field areas such as processing, heating, and drying food, medical, waste management, pyrolysis of different materials (tyres, plastics, timber, biomass, municipal solid waste), sintering, cooking, pasteurizing, and synthesis of chemical compounds, ceramics, and many other processes.

Plastics, due to their deficient dielectric properties, are transparent to microwave heating. Therefore, an absorbent with a high dielectric loss factor must be mixed with the plastic to heat the plastic in pyrolysis. Tyre shredder, silicon carbide, and carbon are good candidates for absorbents. The mechanism of plastic microwave pyrolysis refers to absorbing the microwave energy via absorbent and subsequently transferring thermal heat to the plastic via conduction. The physical properties and the volume ratio of the absorbent affects the uniformity of heating distribution.

Microwaves are widely used in the chemical industry to accelerate chemical reactions. The biggest challenges in this area of study are the non-linear response prediction of the reaction system to the microwave and the design of highly efficient and homogeneous-heating reactors. Not many investigations have quantitatively evaluated microwave heating, considering Multi-physics (chemical reaction, electromagnetic field, and heat transfer). Modelling of microwave heating is vital to achieving a good understanding of the volumetric heating process. Microwave heating is complicated to model because the product's rate of energy absorption and temperature distribution is governed by the products' physical, thermal and electrical properties, which change with temperature during radiation and field distribution. The main aim in microwave reactor design based on modelling results is to efficiently couple the microwave energy with the plastic.

There are some limitations in the design of the microwave reactor related to thermal runaway, voltage

[Continued on next page](#)

## INTERNATIONAL NEWS

### South Korea to build pyrolysis recycling center for ocean waste at southern port city

**SEOUL -- South Korea will build a recycling center that uses the pyrolysis technique to break down plastic ocean waste into fuel. The center will be built at the southern port city of Tongyeong, which has one of the country's biggest fish resources.**

About 50 percent of ocean waste in South Korea is composed of fishnets and buoys made of plastic. Fishnets that are lost or abandoned cause damage to the marine environment. A pyrolysis process breaks down plastics and vinyl to convert waste into oil. The oil is processed into medium crude and light oil which can be used as fuel or for lubricants. Different pyrolysis techniques are widely researched to tackle environmental problems.

Tongyeong said in a statement on July 20 that some 15 billion won (\$NZD 13 million) will be spent on building the recycling center by the end of 2022 to recycle ocean wastes including plastic fishnets, Styrofoam buoys and vinyl. Recycled oil will be used to power fishing vessels, factories, thermal power plants, and heating houses. Currently, ocean waste coated with sea salt is incinerated as it takes a complicated process to recycle.

*(Used by permission Park Sae-jin swatchsjp@ajunews.com)*



breakdown, and arcing. In the design of the microwave unit, the following consideration must be considered:

1. Adjust the field intensity. The field intensity should be limited to prevent arcing and, at the same time, must be high enough to allow rapid treatment without significant heat loss.
2. Eliminate gaps in the inner surface of the unit to prevent the sapping of microwave energy. Unaligned contacts between flanges and fittings create high electrical resistance, leading to localised overheating and arcing.
3. Eliminate the dust inside the wave-guide system.
4. Eliminate sharp corners and edges.
5. Conduct precise tuning procedures to prevent coupling the arc with reflected power.

The volumetric heating, higher power densities, selective energy absorption, instant on and off control without pre or post preparation, improved yields, and enhanced product performance makes microwave heating a better option than conventional heating in some applications. However, creating uniform energy distribution on a large scale can be challenging alongside combining the chemical and electrical engineering technologies to meet the requirements for a high-temperature microwave processing of plastic degradation.

Due to the complex nature of plastic pyrolysis, a very particular and detailed design with the help of a robust electromagnetic simulation model such as QuickWave-3d, COMSOL, and Microwave Studio can provide some insight into microwave behaviour with regards to energy dissipation and electromagnetic wave distribution. A design for a specific application should include conducting numerical modelling considering multi-physics, and the kinetic study under microwave radiation.



## NATIONAL NEWS

### Strategic partnership with Energy Skills Aotearoa signed at WITT

**A new skills partnership has been launched at WITT to grow the number of skilled energy workforce supporting the transition to lower emissions.**

Energy Skills Aotearoa (as part of Energy Resources Aotearoa) and Te Pūkenga have signed a Memorandum of Understanding (MOU) to work together on this challenge.

“As New Zealand moves towards a lower emissions economy, the energy workforce has a challenge to meet the future skill needs of emerging industries,” says Energy Resources Aotearoa Skills Manager Sheree Long.

“We have to support, retain and retrain our current highly-skilled workforce who will be crucial in this transition. The planning for this needs to start now.”

The first step will be to develop an industry skills action plan for the broader energy sector including both renewable and non-renewable companies. This work will be led by Energy Skills and supported by Te Pūkenga.

Te Pūkenga Deputy Chief Executive Employer Journey and Experience Warwick Quinn says the creation of Te Pūkenga provides real opportunities

for skills planning with industry and to develop expertise that is aligned to climate change goals.

“The mahi we are doing is an upscaling exercise in the long term. We want more learners and employers to be involved and this will happen as industries, like the energy sector, look at upskilling their workforces and supporting their people to apply existing skills to new technologies and new challenges.

“Te Pūkenga can bring a nationwide view and look at a range of learning options that meet the needs of both learners and employers so that learning becomes a life-long and positive experience,” he said.

“WITT is committed to equipping the skilled energy workforce of the future,” says John Snook, CE of WITT.



### Signing the MOU between Te Pukenga and Energy Skills Aotearoa



Steven Town (CE of Te Pukenga) and John Carnegie (CE of Energy Resources Aotearoa), signing the Memorandum of Understanding at WITT, Taranaki).

## New Zealand Hydrogen Refuelling Network in Planning stages

New Plymouth based Hiringa Energy has been developing a green hydrogen production and refueling network across New Zealand focused primarily on the heavy vehicles market. Phase 1 of the development includes eight refueling stations across the North and South islands, with the first of the sites planned to start construction in 2022. Phase 2 includes the introduction of a further 16 stations from 2024, and; Phase 3 is for over 100 stations by the year 2030.

Sites in Tauranga, Hamilton, New Plymouth, Auckland, Palmerston North, Christchurch, Taupo and Wellington have already been identified as part of Phase 1.

[Click here for Hiringa Network](#)

## Electric car batteries with five-minute charging times being developed

Batteries capable of fully charging in five minutes have been produced in a factory for the first time, marking a significant step towards electric cars becoming as fast to charge as filling up petrol or diesel vehicles.

Electric vehicles are a vital part of action to tackle the climate crisis but running out of charge during a journey is a worry for drivers. The new lithium-ion batteries were developed by the Israeli company StoreDot and manufactured by Eve Energy in China on standard production lines.

StoreDot has already demonstrated its "extreme fast-charging" battery in phones, drones and scooters and the 1,000 batteries it has now produced are to showcase its technology to carmakers and other companies. Daimler, BP, Samsung and TDK have all invested in StoreDot, which has raised \$130m to date and was named a Bloomberg New Energy Finance Pioneer in 2020.

The batteries can be fully charged in five minutes but this would require much higher-powered chargers than used today.

<https://techxplore.com/news/2021-03-israeli-minute-battery-aims-electric.html>

## Ara Ake produces a "Total Cost of Ownership" tool for alternative fuels in long-distance heavy freight.

Road transport accounts for 17.9% of the countries total greenhouse gas emissions (New Zealand's Greenhouse Gas Inventory 1990-2017), with the Ministry of Transport reporting that New Zealand's heavy truck fleet contributes 27% of all transport emissions but accounts for only 7% of total annual travel.

The tool takes a 'total cost of ownership' (TCO) approach to calculating the cost of road freight movements. This means rather than



just looking at the upfront cost of buying different types of vehicles, it estimates the relative costs of using different vehicles powered by different fuels for a given freight trip. It is intended to be a flexible tool for interested parties to determine what needs to be true for a vehicle and fuel combination to be the lowest-

Continued on next page

## Energy in New Zealand 2021 Factsheet

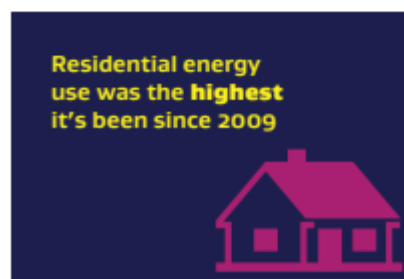
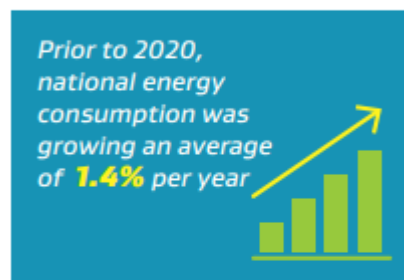
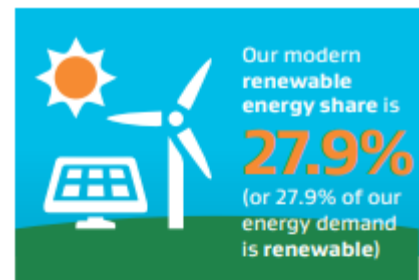



Continued from previous page

cost option. The tool comes with a set of inbuilt assumptions about various factors, such as the cost of electricity, vehicle capital costs, the cost of various fuels, and road user

charges. It also incorporates typical data on average daily heavy freight trips provided by EROAD, including information on average daily kilometres travelled, average number and length of stops, and average speed. However, users are free to run and save their own scenarios and input their own company specific data. This enables the tool to incorporate commercially sensitive data giving companies a bespoke solution to their needs.

The tool (available as a Microsoft Excel document) is accompanied by

a user guide (available as a PDF file). Both are available for free once you have registered your details when you access Ara Ake's website.

[Click here for Ara Ake](#)

Ara Ake is New Zealand's new energy centre, based in Taranaki. They collaborate across the energy ecosystem to accelerate the demonstration and commercialisation of energy innovation to support the transition to low-emissions energy future for New Zealand.



Future Energy Development

## New Zealand's emissions and energy profile by sector

Nearly 41% of NZ's greenhouse gas emissions come from the energy sector

- WASTE
- ENERGY
- AGRICULTURE
- INDUSTRIAL PROCESSES

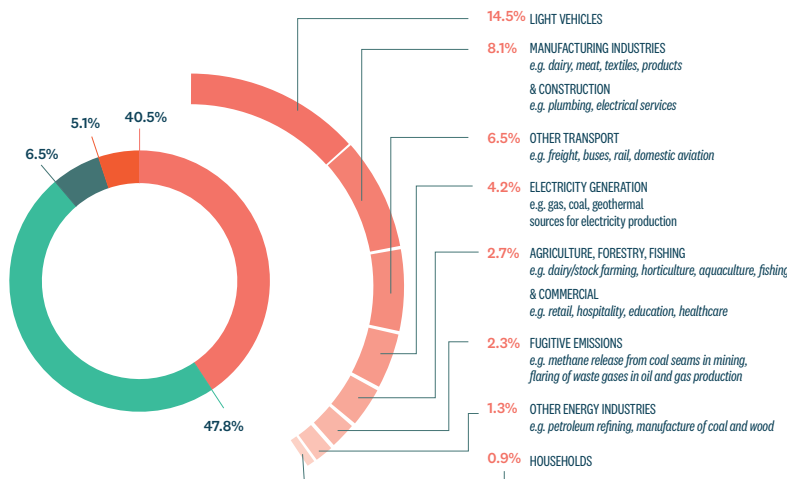

Over two thirds of the total energy used in New Zealand comes from non-renewable energy sources—particularly transport fuels.

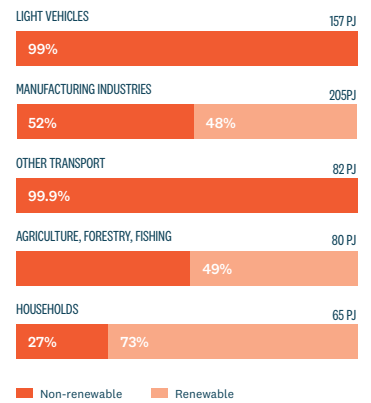

SOURCE: Energy Efficiency Conservation Authority (EECA)



2 December 2021  
INTERCONTINENTAL, WELLINGTON

- HOME
- ABOUT
- PROGRAMME
- SPONSORS
- SPEAKERS
- ADVISORS
- CONTACT
- 
- REGISTER

# Tools, targets and real world solutions

2 December 2021 | Wellington

PLATINUM SPONSORS



WESTERN INSTITUTE OF TECHNOLOGY AT TARANAKI  
TE KURA MATATINI O TARANAKI



Future Energy Development



## Energy Innovation Fund (Victoria, AUS).

The Victorian Government has invested \$108 million through the Energy Innovation Initiative to push frontiers in energy innovation, and is inviting applications from emerging renewable technologies to accelerate the state's journey to net-zero emissions by 2050.

The Energy Innovation Fund grants range from \$2 million to \$20 million, and span renewable hydrogen, energy storage and renewable biogas, to further grow Victoria's renewable technology industry.

The Energy Innovation Fund supports projects to reach commercialisation through feasibility and pre-investment studies, front-end-engineering-design, large scale pilots and demonstrations.

<https://www.pv-magazine-australia.com/press-releases/powering-investment-in-renewable-energy-innovation/>

## Clean energy technology demand will quadruple need for critical minerals.

According to the International Energy Agency's Global EV Outlook, the number of electric cars, vans, heavy trucks and buses on the road is set to reach 145 million by 2030, based on current trends and policy settings. And it could go much higher if governments accelerate efforts to reach international climate goals. However, this will still be a small fraction of the estimated 2 billion internal combustion engines currently in global use running on fossil fuels.

Manufacturing the typical electric car uses 6 times the mineral inputs of a conventional vehicle and an offshore wind farm requires 13 times more than a similarly sized gas-fired plant.

The global clean energy transition will have far-reaching consequences for mineral demand over the next 20 years. By 2040, total mineral demand from clean energy technologies will need to quadruple.

<https://www.openaccessgovernment.org/clean-energy-technology/110259/>

## Turning farmyard waste Into clean energy (UK)

Bennamann, a pioneering cleantech company in the farming county of Cornwall that collects fugitive methane and turns it into "better-than-zero-carbon" fuel. Bennamann captures the biogas – gases from organic matter – from farms and processes, converting it into green fuel that's collected from farms and aggregated with fuel from other sites and sold into the energy market.

Sourcing energy from local waste resources, distributing energy to local people, and creating local jobs without needing a connection to an electricity grid or gas main is a powerful circular economy strategy. Bennamann can produce 4,600 kg of methane per hectare of grass, roughly equivalent to seven and a half thousand litres of petrol from two football pitches.

<https://www.forbes.com/sites/sap/2021/08/19/from-cornwall-uk-turning-farmyard-waste-into-pioneering-clean-energy/?sh=3e84b395bba9>

## Methanex are part of a renewable methanol trial plant (Iceland).

Methanex commenced their partnership with an initial \$5 million investment in Carbon Recycling International (CRI), a privately held company with headquarters in Reykjavik, Iceland.

CRI operates the world's first renewable methanol plant in Iceland, which utilizes its emissions-to-liquids (ETL) technology, converting renewable energy and recycled CO<sub>2</sub> emissions to renewable methanol.

CRI markets its renewable methanol in Europe under the registered brand name Vulcanol, where it is blended with gasoline and used for production of biodiesel. Vulcanol is certified by the International Sustainability and Carbon Certification system (ISCC) as an ultra-low carbon, advanced renewable transport fuel with no biogenic footprint.

## Japan's efforts toward increasing the use of hydrogen energy.

In 2017, the Japanese Government concluded the "Basic Hydrogen Strategy" to accomplish a world-leading hydrogen-based society. The strategy shows future visions toward 2050 and also serves as an action plan to accomplish the visions by 2030. The strategy sets a goal that Japan should reduce hydrogen costs to the same level of conventional energy and to achieve the goal, provides integrated policies across ministries ranging from hydrogen production to utilisation under the common goals.

In Japan, the commercial realisation of a household fuel cell system (ENE-FARM), as well as commercial and industrial fuel cells was achieved in 2009 and 2017, respectively. And in 2014, a fuel cell vehicle (FCV) was put on sale in Japan ahead of other countries.

As Prime Minister Suga declared in October 2020 that Japan would aim for the realisation of carbon neutrality by 2050, there are increasing expectations concerning the roles hydrogen can play. For further hydrogen cost reduction, it is important to design how hydrogen should be utilised in the entire energy system in the future, such as by integration with renewable and existing energies, while enhancing production, transportation and utilisation technologies in a unified manner.

<https://www.openaccessgovernment.org/japans-efforts-toward-increasing-the-use-of-hydrogen-energy/103900/>

## Two major oil companies, bp and Total, are among the six new offshore wind projects in the UK.

The Offshore Wind Leasing project is proceeding into Round 4, meaning that 7GW of offshore wind projects are up for grabs that could power more than six million homes in the UK. Offshore wind licenses auctions by the Government have seen BP agree to pay £924 million for two sites in the Irish sea, with French oil company Total also making a large bid for the license.

## Solar power initiative win for Māori households and future renewable projects

Solar panels and other renewable technology will support more than 200 homes of kaumātua, papakāinga and Māori-owned rentals

This is to provide cheaper power, warmer, and drier homes, and valuable data. It's part of the Government's focus on creating targeted renewable energy solutions for Māori and public housing.

Fifteen initiatives will receive funding for renewable energy projects in the Fund's first round (\$2.8m). In total \$14 million will go to renewable energy projects for Māori housing over the next four years.

Some of the projects will go even further by installing household batteries to store surplus electricity, replacing the use of diesel generators to build community resilience, and

to trial innovative solutions to share power with others.

By focusing on projects that benefit multiple households – many using innovative distribution and retail solutions – the government is gaining valuable insight into the operational, economic, environmental and wellbeing impacts of renewable energy systems. This insight can help inform larger-scale projects in the future.

Approximately \$14 million has also been committed to fund renewable energy projects on public housing. This fund is being managed separately and funding announcements will be made in the coming months.

Projects predominantly led by, or for, Māori-affiliated or Māori-run organisations were prioritised for funding.

[Click here for Beehive News](#)



## Energy in New Zealand 2021 report published

This is MBIE's annual round-up of the energy sector, highlighting key trends in energy supply, transformation, demand and prices for the 2020 calendar year.

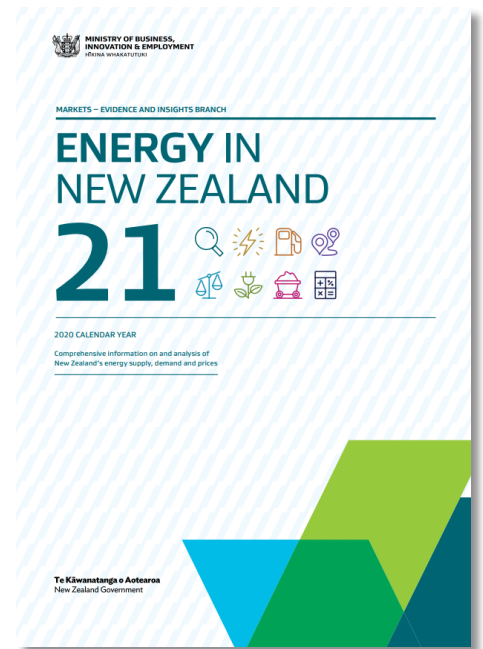

Click on the link below to go to Energy in New Zealand 2021

<https://www.mbie.govt.nz/dmsdocument/16820-energy-in-new-zealand-2021>

Click on this link to the **NZ Energy Dashboard**

[www.energydashboard.mbie.govt.nz](http://www.energydashboard.mbie.govt.nz)



## A battery swapping station for electric trucks is among new low emission transport projects getting government co-funding.

So far, we only have a few dozen electric trucks on the road but innovations like battery swapping stations for E trucks will save valuable time for trucking companies. It will mean they'll be able to quickly swap in a fully charged battery to continue their journey, leaving the old battery for recharging later and at off-peak times when electricity is cheaper. (July 2021)